

Article number: 391804901843210

Description: Worm gear with st. steel hollow shaft  
VF 49 EP-F2-18- 80B5

## Measures

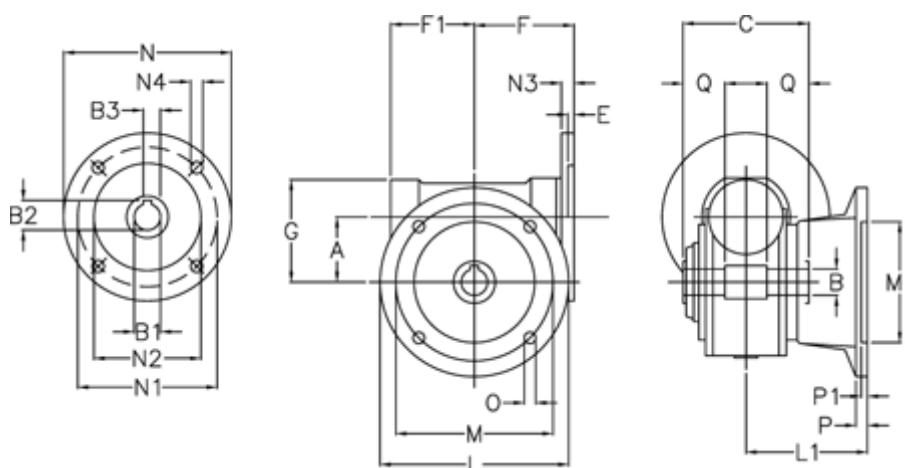

a	= 49.5	F1 = 63	N2 = 130
B	= 25	g = 80	N3 = 10.0
B1 E7	= 19	L = 125	N4 = 11.5
B2	= 21.8	L1 = 85.5	O = 10.5
B3 H9	= 6	m = 90	P = 12
C	= 82	M1 = 70	P1 = 10
E	= 3.0	N = 200	Q = 22.5
F	= 70	N1 = 165	